



# **BLADES & HORSESHOES**

# BLADES & HORSESHOES

- KEY MACHINES
- KEY BOARDS
- KEY CUTTING ACCESSORIES
- COINING
- NOVELTY
- HOUSEHOLD
- WINDOW
- MORTICE
- CAR & TRUCK
- MOTORCYCLE
- OTHER VEHICLE
- INDUSTRIAL
- NON TRANSPONDERS
- PETROL CAP
- PODS & INSERTS
- BLADES & HORSESHOES
- REMOTE KEY SHELLS
- CHIPS
- KEYLINE HORSESHOES
- KEY DIY
- XHORSE & VVDI

## ALFA ROMEO

## ASTON MARTIN

## AUDI

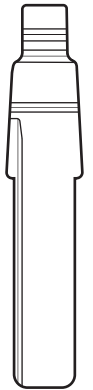
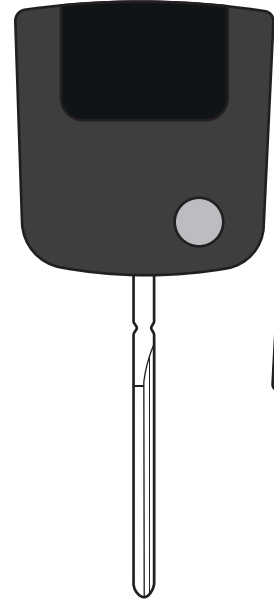
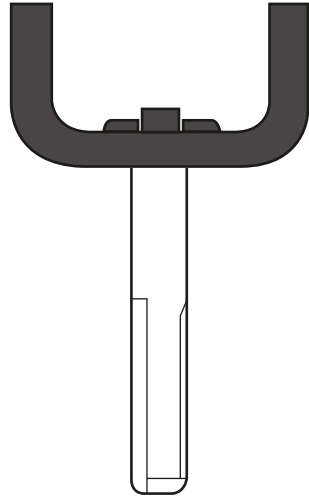

BLADE ONLY VIEW



**SIP18T**  
XC280

SILCA: SIP18T  
JMA: SIP 18T



**HU43AT**  
RB1018

SILCA: HU43AT  
JMA: OP-WH.TL



**HU75T**  
XC234

SILCA: HU75T  
JMA: HU-HAAC2  
or HU-HAAC1



**HU66T**  
RB1015

SILCA: HU66T



**VGB2**  
RB1009

SILCA: HU66

## AUDI

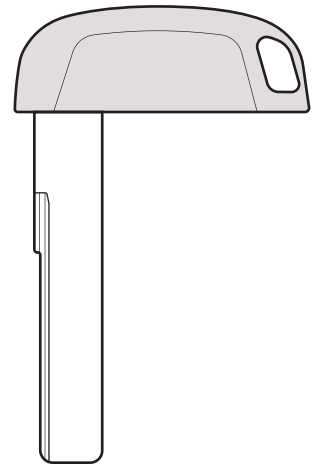
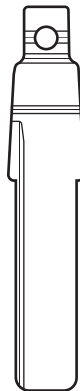
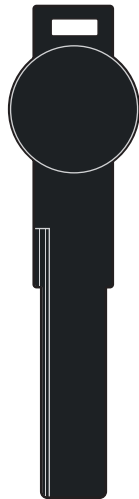

**HU162T**  
RB1031

SILCA: HU162T  
JMA: HU-4C1



**HU-HAAC13**  
RB1052

JMA: HU-HAAC13



**HU-HAAC3**  
RB1054

JMA: HU-HAAC3



**VGB6**  
RB1055

SILCA: HU103T  
JMA: HU-HAAC4



**VGB8**  
RB1060

SILCA: HU66  
JMA: RMAU07-BLADE

## AUDI

## BMW

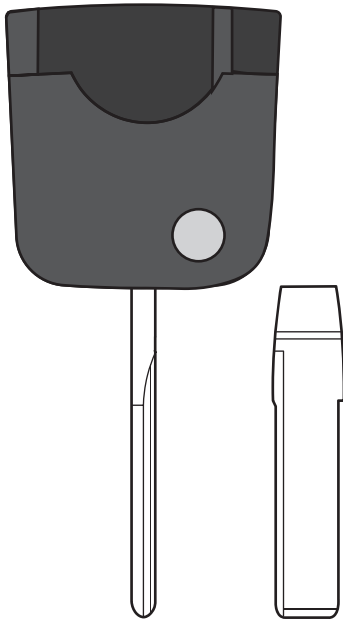
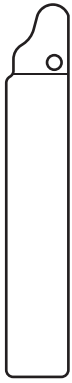

BLADE ONLY  
VIEW

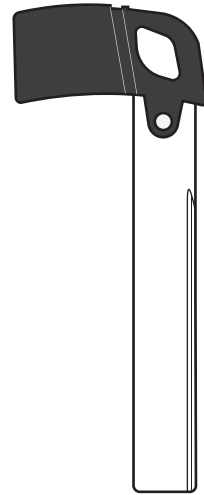

**HU75T**  
VGB1

SILCA: HU75T  
JMA: HU-HAAC2



**PEB8**  
TP626

SILCA: HU107T  
JMA: HU-HCAC8  
or HU-NAAC2



**RMAU01-FLIP**  
RB1077

JMA: RMAU01-FLIP



**HU92**  
RB1061

SILCA: HU92  
JMA: RMBM05-BLADE

# BLADES & HORSESHOES

- KEY MACHINES ■
- KEY BOARDS ■
- KEY CUTTING ACCESSORIES ■
- COINING ■
- NOVELTY ■
- HOUSEHOLD ■
- WINDOW ■
- MORTICE ■
- CAR & TRUCK ■
- MOTORCYCLE ■
- OTHER VEHICLE ■
- INDUSTRIAL ■

## BMW

## CITROËN

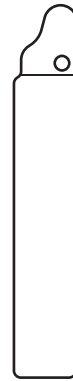
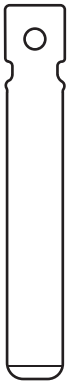
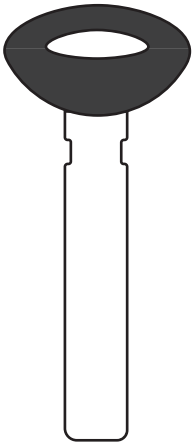

**HU92R**  
BMB1

SILCA: HU92R



**CTB1**  
TP594

SILCA: VA2T  
JMA: CIT-1C9



**CTB2**  
RB1010

SILCA: SX9  
JMA: RMCT50-BLADE



**SIP29T**  
TP622

SILCA: SIP29T



**VA7T**  
TP624

SILCA: VA7T  
JMA: PEU-1C1



**PEB8**  
TP626

SILCA: HU107T  
JMA: HU-HCAC8  
or HU-NAAC2

- NON TRANSPONDERS ■
- PETROL CAP ■
- PODS & INSERTS ■
- BLADES & HORSESHOES ■
- REMOTE KEY SHELLS ■
- CHIPS ■
- KEYLINE HORSESHOES ■
- KEY DIY ■
- XHORSE & VDI ■

# BLADES & HORSESHOES

## CITROËN

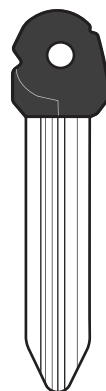
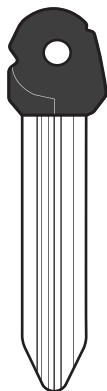

**SIP18T**  
XC280

SILCA: SIP18T  
JMA: SIP 18T



**VA2**  
RB1039

SILCA: VA2  
JMA: CIT-1C4



**RMCT51-BLADE**  
RB1062

JMA: RMCT51-BLADE



**CTB3**  
RB1063

SILCA: CTB3  
JMA: RMCT52-BLADE



**SIP22**  
PEB12

SILCA: SIP22

- KEY MACHINES
- KEY BOARDS
- KEY CUTTING ACCESSORIES
- COINING
- NOVELTY
- HOUSEHOLD
- WINDOW
- MORTICE
- CAR & TRUCK
- MOTORCYCLE
- OTHER VEHICLE
- INDUSTRIAL
- NON TRANSPONDERS
- PETROL CAP
- PODS & INSERTS
- BLADES & HORSESHOES
- REMOTE KEY SHELLS
- CHIPS
- KEYLINE HORSESHOES
- KEY DIY
- XHORSE & VVDI

## CITROËN

## DACIA

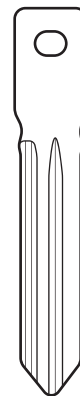
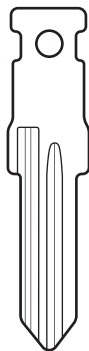

**FI-16C1**  
XC295

JMA: FI-16C1



**DAC-3DC1**  
RB1040

JMA: DAC-3DC1



**HU136TA**  
RB1041

SILCA: HU136TA  
JMA: DAC-4DC1



**DAC-5C1**  
RB1042

JMA: DAC-5C1



**DAC-6DC1**  
RB1043

JMA: DAC-6DC1

**DACIA**

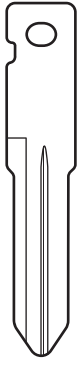

**DAC-7DC1**  
RB1044

JMA: DAC-7DC1

**FIAT**



**SIP29T**  
TP622

SILCA: SIP29T  
JMA: CIT-1C4



**SIP18T**  
XC280

SILCA: SIP18T  
JMA: SIP 18T



**FI-16C1**  
XC295

JMA: FI-16C1



**SIP22**  
PEB12

SILCA: SIP22

**BLADES & HORSESHOES**

- KEY MACHINES
- KEY BOARDS
- KEY CUTTING ACCESSORIES
- COINING
- NOVELTY
- HOUSEHOLD
- WINDOW
- MORTICE
- CAR & TRUCK**
- MOTORCYCLE
- OTHER VEHICLE
- INDUSTRIAL

**FORD**



**FOB6**  
TP601

SILCA: HU101T  
JMA: FO-24C1



**HU97T**  
TP602

SILCA: HU97T  
JMA: FO-24C2



**SIP29T**  
TP622

SILCA: SIP29T

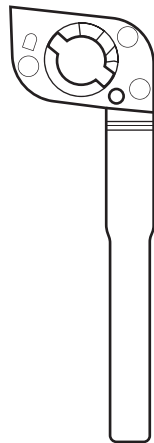

**TRK-FORD-06-2**  
RB1002

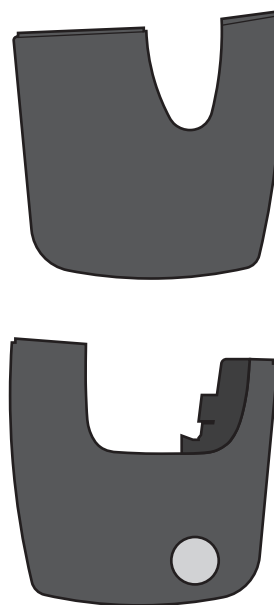

**FOB14C**  
RB1030

SILCA: HU101T  
JMA: RMFD09-BLADE



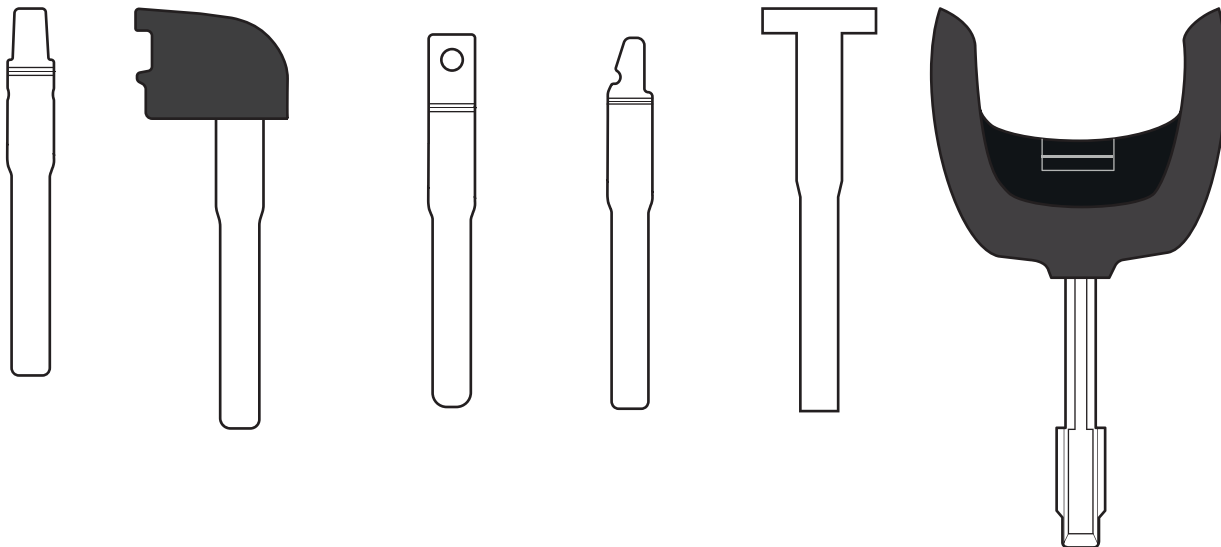

- NON TRANSPONDERS
- PETROL CAP
- PODS & INSERTS
- BLADES & HORSESHOES
- REMOTE KEY SHELLS
- CHIPS
- KEYLINE HORSESHOES
- KEY DIY
- XHORSE & VDI

# BLADES & HORSESHOES

## FORD



- KEY MACHINES
- KEY BOARDS
- KEY CUTTING ACCESSORIES
- COINING
- NOVELTY
- HOUSEHOLD
- WINDOW
- MORTICE
- CAR & TRUCK
- MOTORCYCLE
- OTHER VEHICLE
- INDUSTRIAL
- NON TRANSPONDERS
- PETROL CAP
- PODS & INSERTS
- BLADES & HORSESHOES
- REMOTE KEY SHELLS
- CHIPS
- KEYLINE HORSESHOES
- KEY DIY
- XHORSE & VVDI

					
<b>FO-24C9</b> RB1046	<b>RMFD09 - BLADE</b> RB1064	<b>FO-24C8</b> RB1070	<b>FD40</b> CV121	<b>HU101</b> XCV033	<b>FO21AP</b> TP598
JMA: FO-24C9	JMA: RMFD09-BLADE	JMA: FO-24C8			SILCA: FO21AP JMA: FO-6.TL

## FORD

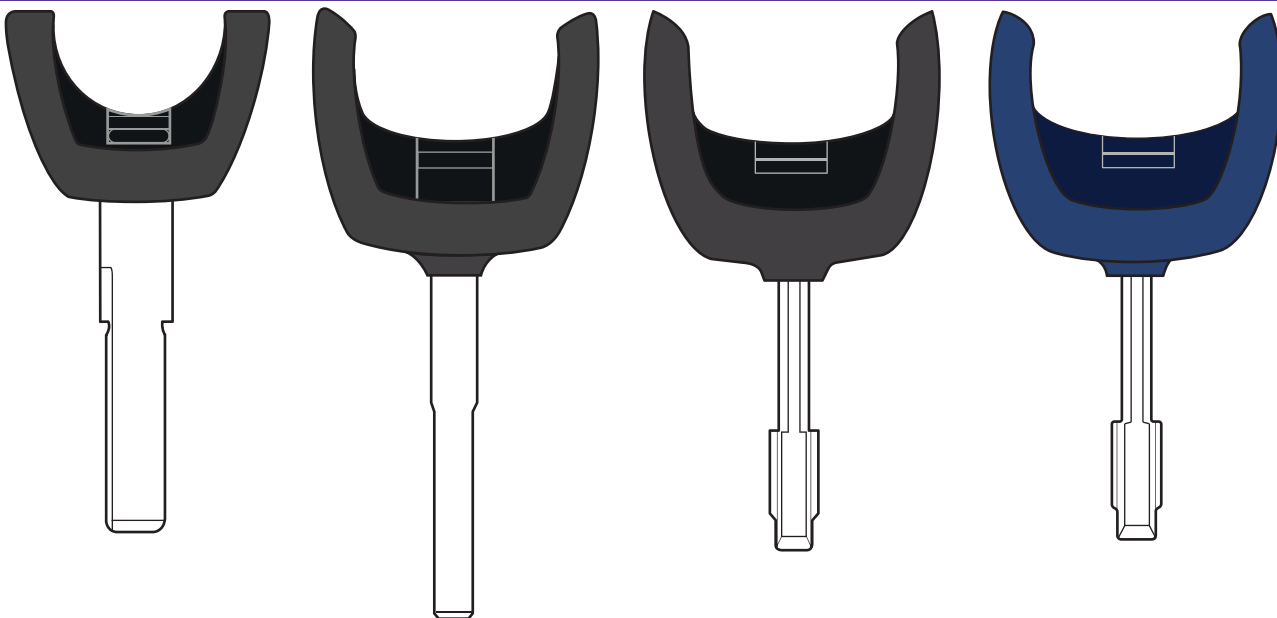

			
<b>HU66CT</b> RB1014	<b>HU101AP</b> CV035	<b>FD3AP</b> CV036	<b>FOB3G-BU</b> TP599
SILCA: HU66CT JMA: HU-HAA.TL	SILCA: HU101AP JMA: FO-24.TL	T ..... 1234 SILCA: FO21AP JMA: FO-6.TL	SILCA: FO21APB

**FORD**

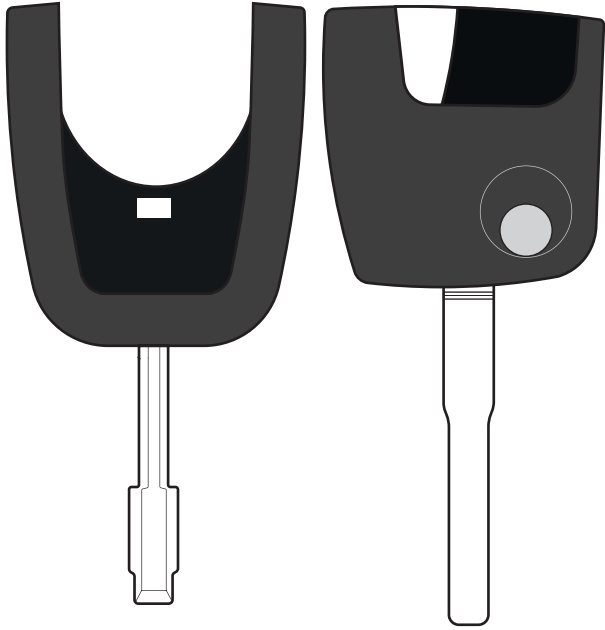

**FO21 IR**  
FOB4

**HU101**  
FOB8

SILCA: HU101  
JMA: RMFD03-FLIP

**HYUNDAI**

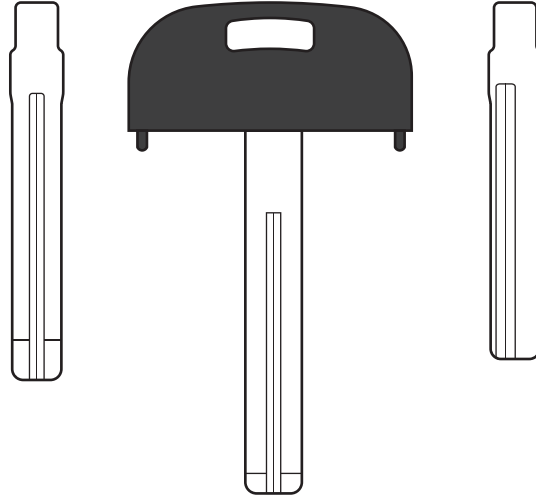

**KIA8T**  
TP607

**HY-18P1C1**  
RB1078

JMA: HY-18P1C1

**HYN17T**  
TP609

SILCA: HYN17T  
JMA: HY-19D

**BLADES & HORSESHOES**

- KEY MACHINES
- KEY BOARDS
- KEY CUTTING ACCESSORIES
- COINING
- NOVELTY
- HOUSEHOLD
- WINDOW
- MORTICE
- CAR & TRUCK
- MOTORCYCLE
- OTHER VEHICLE
- INDUSTRIAL

**HYUNDAI**

**IVECO**

**JAGUAR**

**KIA**

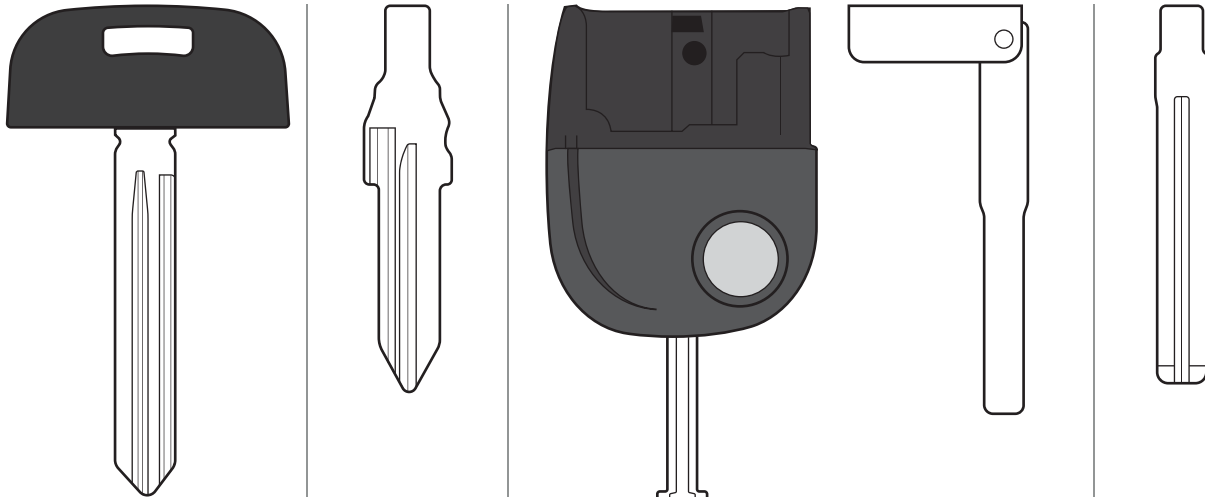

**HY-11.P4C1**  
RB1057

JMA: HY-11.P4C1

**IB1**  
TP603

SILCA: GT10

**RMJR01-FLIP**  
RB1065

JMA: RMJR01-FLIP

**HU101**  
LRB4

SILCA: HU101

**KIA8T**  
TP607

SILCA: KIA8T  
JMA: KI-7

- NON TRANSPONDERS
- PETROL CAP
- PODS & INSERTS
- BLADES & HORSESHOES
- REMOTE KEY SHELLS
- CHIPS
- KEYLINE HORSESHOES
- KEY DIY
- XHORSE & WDI

# BLADES & HORSESHOES

- KEY MACHINES
- KEY BOARDS
- KEY CUTTING ACCESSORIES
- COINING
- NOVELTY
- HOUSEHOLD
- WINDOW
- MORTICE
- CAR & TRUCK
- MOTORCYCLE
- OTHER VEHICLE
- INDUSTRIAL
- NON TRANSPONDERS
- PETROL CAP
- PODS & INSERTS
- BLADES & HORSESHOES
- REMOTE KEY SHELLS
- CHIPS
- KEYLINE HORSESHOES
- KEY DIY
- XHORSE & VVDI

## KIA

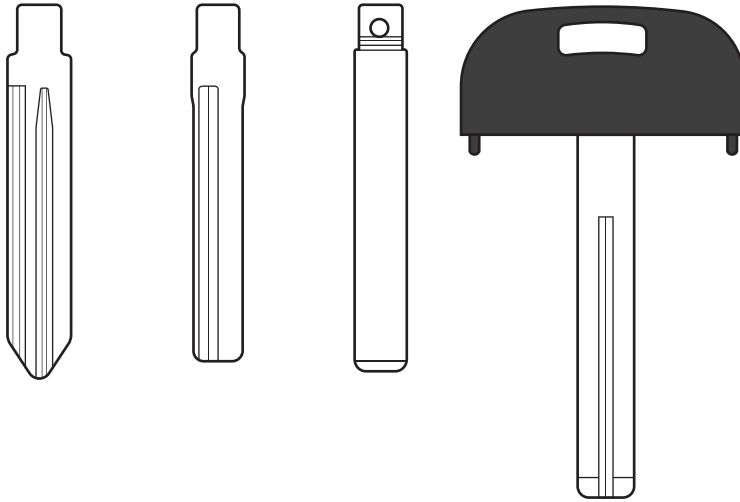

## LAND ROVER

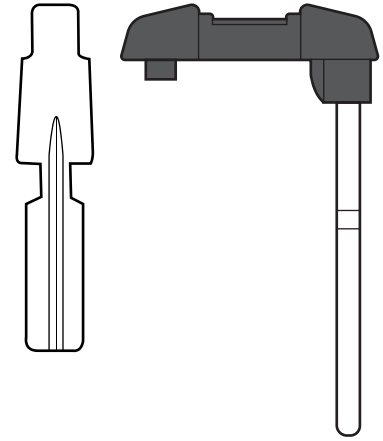

					
<b>HYN14R</b> TP608	<b>HYN17T</b> TP609	<b>KIB4</b> TP610	<b>HY-18P1C1</b> RB1078	<b>HU74T</b> XC235	<b>HU101</b> RB1067
SILCA: HYN14R JMA: HY-11	SILCA: HYN17T JMA: HY-19D	SILCA: KIA15	JMA: HY-18P1C1	SILCA: HU74T JMA: HU 74T	SILCA: HU101 JMA: RMRV04-BLADE

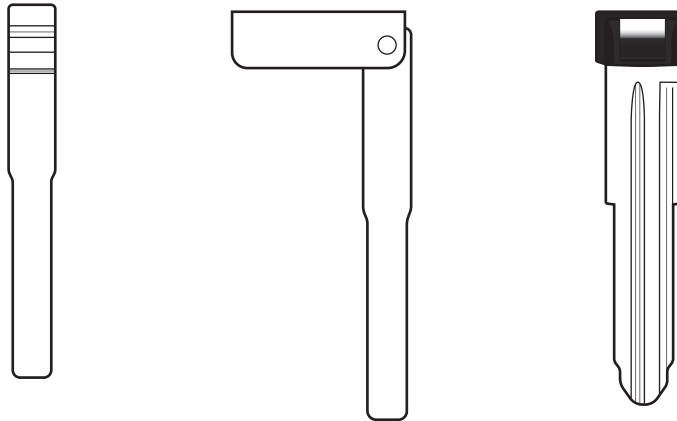

## LAND ROVER

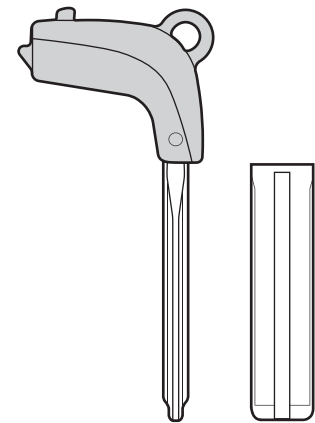

## LEXUS



BLADE ONLY VIEW

			
<b>FOB6</b> TP601	<b>HU101</b> LRB4	<b>RV10-IP</b> XPT130	<b>LXB1</b> TP613
SILCA: HU101T JMA: FO-24C1	SILCA: HU101	SILCA: NE38 JMA: NE-11C3	SILCA: TOY48



**LEXUS**

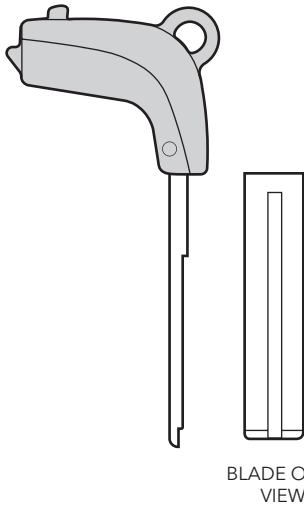

BLADE ONLY VIEW



**LXB2**  
TP614

SILCA: TOY48 (New type)

**MAN**



**HU83T**  
XC279

SILCA: HU83T  
JMA: HU 83T

**MAZDA**

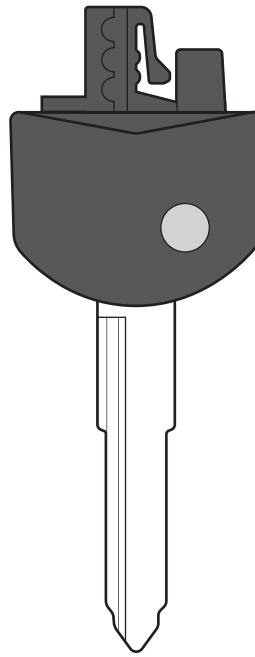

**MAB1**  
RB1069

SILCA: MAZ24R  
JMA: RMMZ01-FLIP



**MAB2C**  
TP616

SILCA: MAZ24R

**BLADES & HORSESHOES**

- KEY MACHINES ■
- KEY BOARDS ■
- KEY CUTTING ACCESSORIES ■
- COINING ■
- NOVELTY ■
- HOUSEHOLD ■
- WINDOW ■
- MORTICE ■
- CAR & TRUCK** ■
- MOTORCYCLE ■
- OTHER VEHICLE ■
- INDUSTRIAL ■

**MERCEDES**

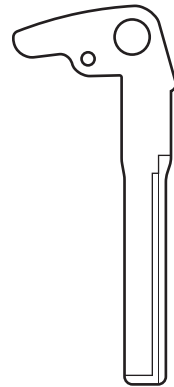
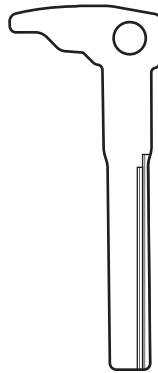
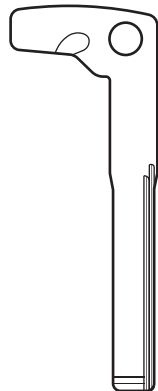

**HU64T**  
XC199

SILCA: HU64T  
JMA: ME-7C8



**HU39T**  
XC200

SILCA: HU39T  
JMA: ME-2C3



**HU126T**  
RB1032

SILCA: HU126T  
JMA: ME-7C9



**ME-7C6**  
RB1033

JMA: ME-7C6



**HU81T**  
RB1034

SILCA: HU81T  
JMA: ME-7C5



**VA11T**  
TP619

SILCA: VA11T  
JMA: DAT-15C2

**NISSAN**

- NON TRANSPONDERS ■
- PETROL CAP ■
- PODS & INSERTS ■
- BLADES & HORSESHOES ■
- REMOTE KEY SHELLS ■
- CHIPS ■
- KEYLINE HORSESHOES ■
- KEY DIY ■
- XHORSE & VWDI ■

- KEY MACHINES
- KEY BOARDS
- KEY CUTTING ACCESSORIES
- COINING
- NOVELTY
- HOUSEHOLD
- WINDOW
- MORTICE
- CAR & TRUCK
- MOTORCYCLE
- OTHER VEHICLE
- INDUSTRIAL
- NON TRANSPONDERS
- PETROL CAP
- PODS & INSERTS
- BLADES & HORSESHOES
- REMOTE KEY SHELLS
- CHIPS
- KEYLINE HORSESHOES
- KEY DIY
- XHORSE & VVDI

NISSAN

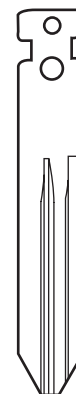
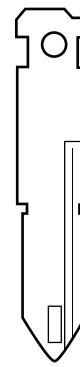

**NSN11T**  
TP620

SILCA: NSN11T  
JMA: DAT-6C1



**NE73AI**  
XC132

SILCA: NE73-AI  
JMA: NE-60C1



**NSN11TB**  
RB1022

SILCA: NSN11TB  
JMA: DAT-6C1



**NE73CI**  
XC233

SILCA: VA3-I  
JMA: NE-60C3



**NS34-I**  
C419

SILCA: NSN14T  
JMA: DAT-15C1

NISSAN

PEUGEOT

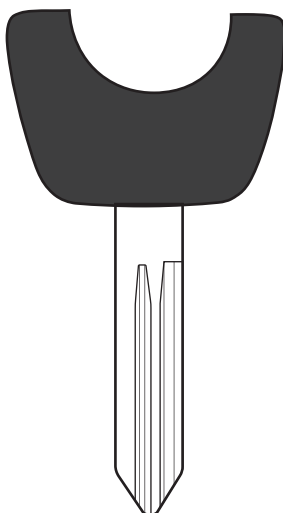
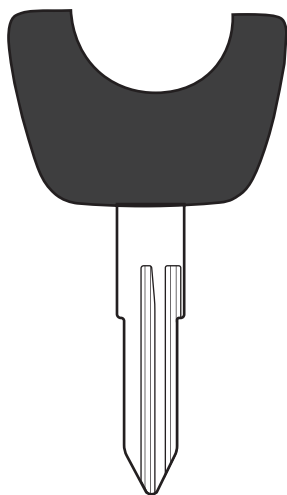

**NSN11AT**  
RB1016

SILCA: NSN11AT  
JMA: DAT-6.TL



**NSN14AT13**  
RB1017

SILCA: NSN14AT  
JMA: DAT-15.TL

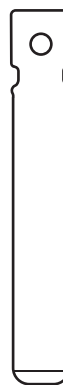

**CTB1**  
TP594

SILCA: VA2T  
JMA: CIT-1C9



**SIP29T**  
TP622

SILCA: SIP29T



**NE78T**  
TP623

SILCA: NE78T  
JMA: NE-51C3

## PEUGEOT



**VA7T**  
TP624

SILCA: VA7T  
JMA: PEU-1C1



**PEB8**  
TP626

SILCA: HU107T  
JMA: HU-HCAC8  
or HU-NAAC2



**NE78**  
TP627

SILCA: NE78  
JMA: PEU-2C1



**NE73AI**  
XC132

SILCA: NE73AI  
JMA: NE-60C1



**NE73CI**  
XC233

SILCA: VA-3I  
JMA: NE-60C3

## BLADES & HORSESHOES



## PEUGEOT

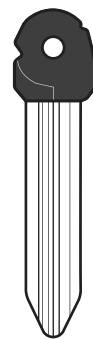

**HU83T**  
XC279

SILCA: HU83T  
JMA: HU 83T



**SIP18T**  
XC280

SILCA: SIP18T  
JMA: SIP 18T



**VA2**  
RB1039

SILCA: VA2  
JMA: CIT-1C4



**VXB13C**  
RB1059

SILCA: VA2  
JMA: PEU-1C5



**CTB3**  
RB1063

SILCA: CTB3  
JMA: RMCT52-BLADE

PEUGEOT

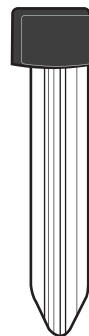
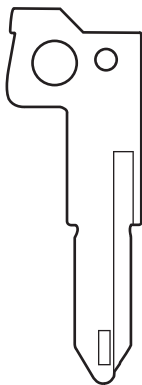

- KEY MACHINES
- KEY BOARDS
- KEY CUTTING ACCESSORIES
- COINING
- NOVELTY
- HOUSEHOLD
- WINDOW
- MORTICE
- CAR & TRUCK
- MOTORCYCLE
- OTHER VEHICLE
- INDUSTRIAL
- NON TRANSPONDERS
- PETROL CAP
- PODS & INSERTS
- BLADES & HORSESHOES
- REMOTE KEY SHELLS
- CHIPS
- KEYLINE HORSESHOES
- KEY DIY
- XHORSE & VDI



**SIP22**  
PEB12

SILCA: SIP22



**NE73-BI**  
XC216

SILCA: NE73-BI  
JMA: NE 73-BI



**NE78T**  
XC054

SILCA: NE78T  
JMA: NE78T



**CTB2**  
RB1010

SILCA: SX9  
JMA: RMCT50-BLADE



**REB10C**  
TP628

SILCA: VA2

PEUGEOT

PORSCHE

RANGE ROVER

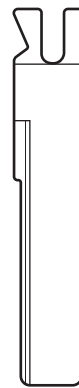

**VAC-102AI**  
TP630

SILCA: VAC-102AI



**REB8**  
TP633

SILCA: VA2/VA6



**HU75T**  
XC234

SILCA: HU75T  
JMA: HU-HAAC2  
or HU-HAAC1



**HU-HAAC14**  
RB1053

JMA: HU-HAAC14



**HU74T**  
XC235

SILCA: HU74T  
JMA: HU 74T

## RANGE ROVER

## RENAULT

# BLADES & HORSESHOES

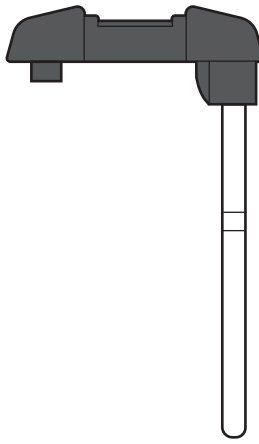
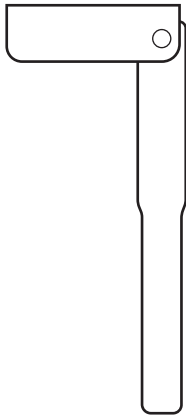
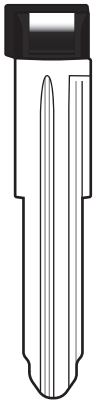

**RV10-IP**  
XPT130

SILCA: NE38  
JMA: NE-11C3



**HU101**  
LRB4

SILCA: HU101



**FOB6**  
TP601

SILCA: HU101T  
JMA: FO-24C1



**HU101**  
RB1067

SILCA: HU101  
JMA: RMRV04-BLADE



**VA7T**  
TP624

SILCA: VA7T  
JMA: PEU-1C1

- KEY MACHINES ■
- KEY BOARDS ■
- KEY CUTTING ACCESSORIES ■
- COINING ■
- NOVELTY ■
- HOUSEHOLD ■
- WINDOW ■
- MORTICE ■
- CAR & TRUCK ■
- MOTORCYCLE ■
- OTHER VEHICLE ■
- INDUSTRIAL ■

## RENAULT

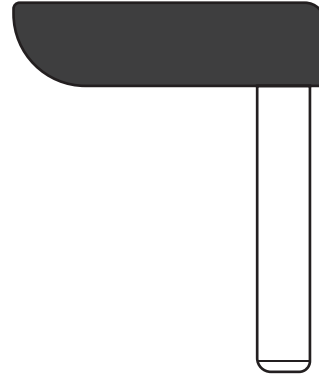
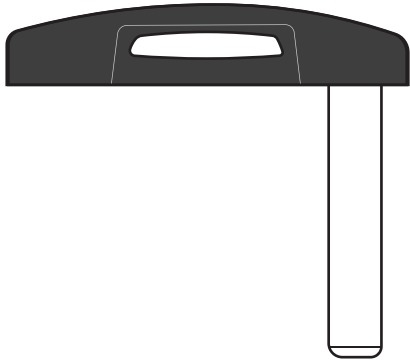

**REB10C**  
TP628

SILCA: VA2



**VXB13C**  
RB1059

SILCA: VA2  
JMA: PEU-1C5



**REB11**  
TP629

SILCA: VA2



**VAC-102AI**  
TP630

SILCA: VAC-102AI



**REB6**  
TP631

SILCA: VA2  
JMA: RMRN04-BLADE

- NON TRANSPONDERS ■
- PETROL CAP ■
- PODS & INSERTS ■
- BLADES & HORSESHOES ■
- REMOTE KEY SHELLS ■
- CHIPS ■
- KEYLINE HORSESHOES ■
- KEY DIY ■
- XHORSE & WDI ■

RENAULT

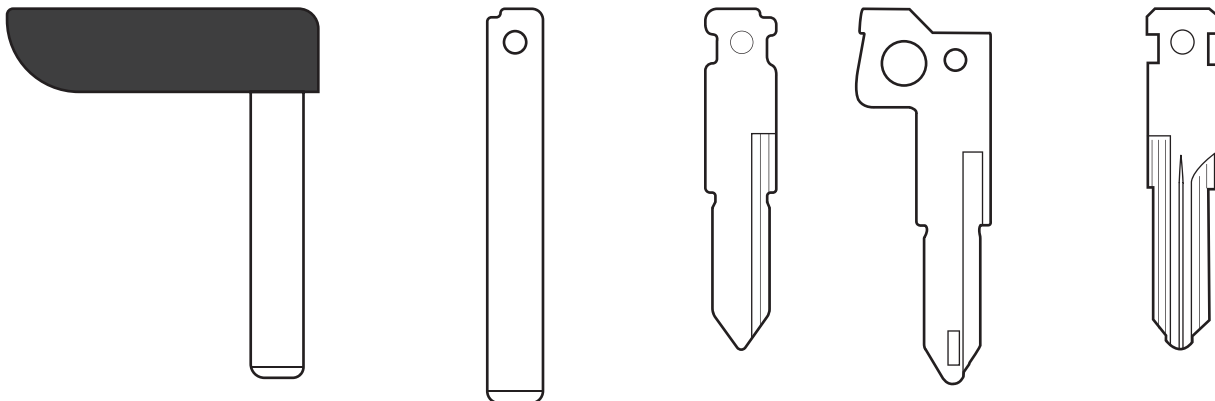

....A/Z 0/9 1-4092  
....A/Z 0/9 5001-9092



**REB7**  
TP632

SILCA: VA2



**REB8**  
TP633

SILCA: VA2/VA6



**DAC-5C1**  
RB1042

JMA: DAC-5C1



**NE73-BI**  
XC216

SILCA: NE73-BI  
JMA: NE 73-BI



**VAC102CI**  
XC087

SILCA: VAC102CI  
JMA: VAC 102-CI

RENAULT

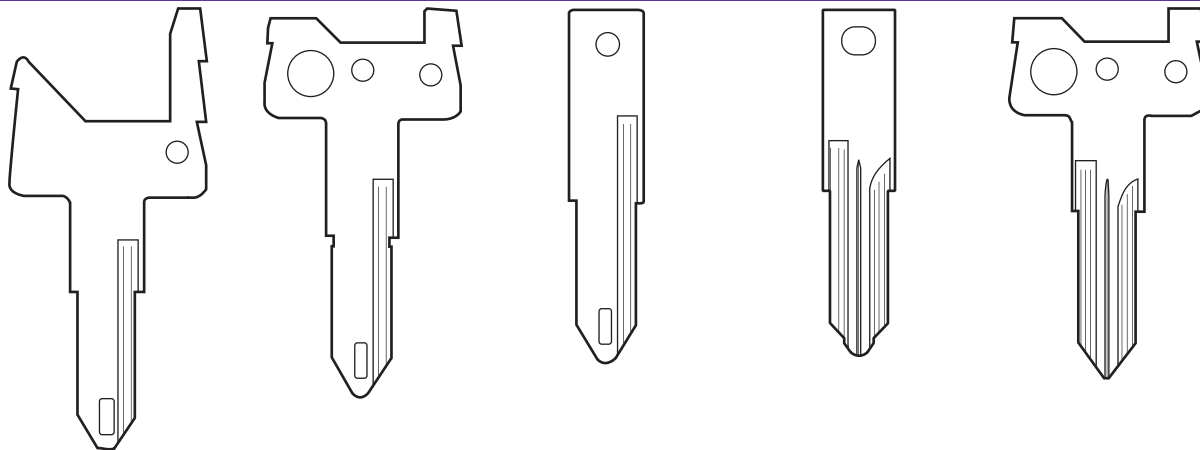

....A/Z 0/9 1-4092  
....A/Z 0/9 5001-9092



**NE72I**  
XC130

SILCA: NE72I  
JMA: NE 72-I



**NE73I**  
XC131

SILCA: NE73I  
JMA: NE-60C2



**NE73AI**  
XC132

SILCA: NE73AI  
JMA: NE-60C1



**VAC102AI**  
XC158

SILCA: VAC102AI  
JMA: VA-61C1



**VAC102I**  
XC161

SILCA: VAC102I  
JMA: VAC-61C2

- KEY MACHINES
- KEY BOARDS
- KEY CUTTING ACCESSORIES
- COINING
- NOVELTY
- HOUSEHOLD
- WINDOW
- MORTICE
- CAR & TRUCK
- MOTORCYCLE
- OTHER VEHICLE
- INDUSTRIAL
- NON TRANSPONDERS
- PETROL CAP
- PODS & INSERTS
- BLADES & HORSESHOES
- REMOTE KEY SHELLS
- CHIPS
- KEYLINE HORSESHOES
- KEY DIY
- XHORSE & VDI

## RENAULT

## ROVER

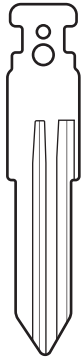
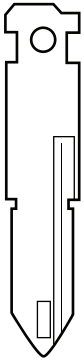

**NE73CI**  
XC233

SILCA: VA-3I  
JMA: NE-60C3



**VA11T**  
TP619

SILCA: VA11T  
JMA: DAT-15C2



**SIP18T**  
XC280

SILCA: SIP18T  
JMA: SIP 18T



**VAC102-BI**  
RB1068

SILCA: VAC102-BI  
JMA: VAC 102-BI



**FOB6**  
TP601

SILCA: HU101T  
JMA: FO-24C1

# BLADES & HORSESHOES

- KEY MACHINES ■
- KEY BOARDS ■
- KEY CUTTING ACCESSORIES ■
- COINING ■
- NOVELTY ■
- HOUSEHOLD ■
- WINDOW ■
- MORTICE ■
- CAR & TRUCK ■
- MOTORCYCLE ■
- OTHER VEHICLE ■
- INDUSTRIAL ■

## ROVER

## SEAT

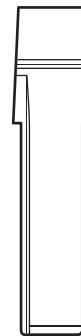
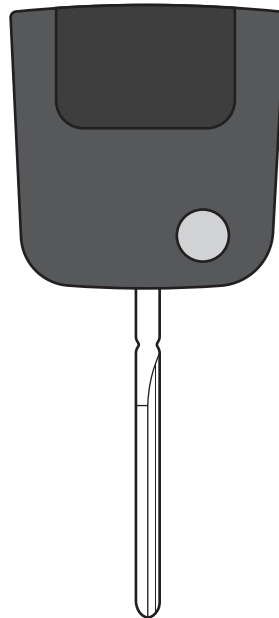
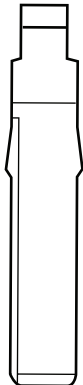
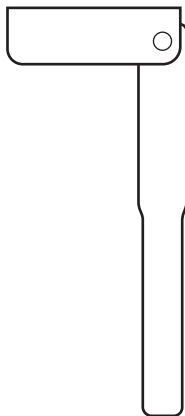
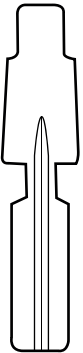

BLADE ONLY VIEW



**HU74T**  
XC235

SILCA: HU74T  
JMA: HU 74T



**HU101**  
LRB4

SILCA: HU101



**HU75T**  
XC234

SILCA: HU75T  
JMA: HU-HAAC2  
or HU-HAAC1



**TRK-AUDI-ROL-R**  
RB1003

- NON TRANSPONDERS ■
- PETROL CAP ■
- PODS & INSERTS ■
- BLADES & HORSESHOES ●
- REMOTE KEY SHELLS ■
- CHIPS ■
- KEYLINE HORSESHOES ■
- KEY DIY ■
- XHORSE & WDI ■

SEAT

SKODA

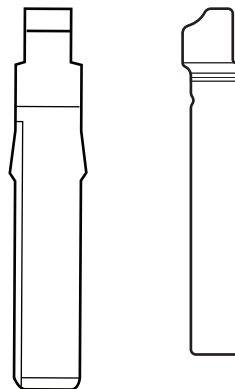
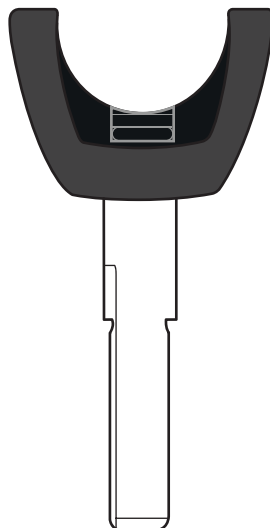
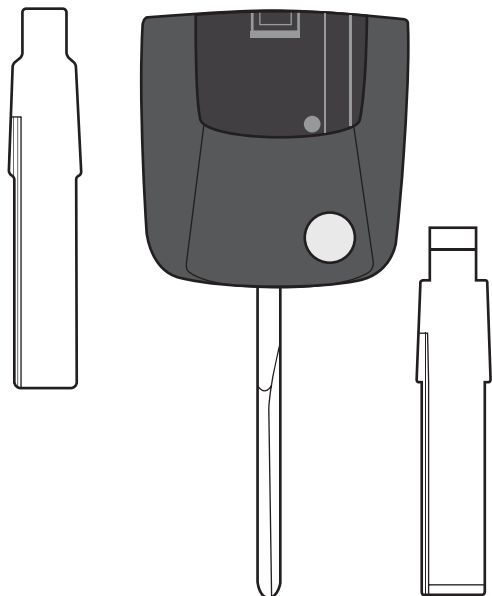

BLADE ONLY FRONT VIEW

- KEY MACHINES
- KEY BOARDS
- KEY CUTTING ACCESSORIES
- COINING
- NOVELTY
- HOUSEHOLD
- WINDOW
- MORTICE
- CAR & TRUCK
- MOTORCYCLE
- OTHER VEHICLE
- INDUSTRIAL
- NON TRANSPONDERS
- PETROL CAP
- PODS & INSERTS
- BLADES & HORSESHOES
- REMOTE KEY SHELLS
- CHIPS
- KEYLINE HORSESHOES
- KEY DIY
- XHORSE & VVDI

**HU75T**  
VGB1  
SILCA: HU75T  
JMA: HU-HAAC2

**VGB14**  
TP634  
SILCA: HU66

**HU66CT**  
RB1014  
SILCA: HU66CT  
JMA: HU-HAA.TL

**HU75T**  
XC234  
SILCA: HU75T  
JMA: HU-HAAC2  
or HU-HAAC1

**HU162T**  
RB1031  
SILCA: HU162T  
JMA: HU-4C1

SKODA

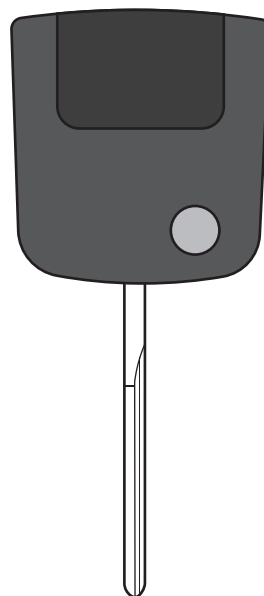
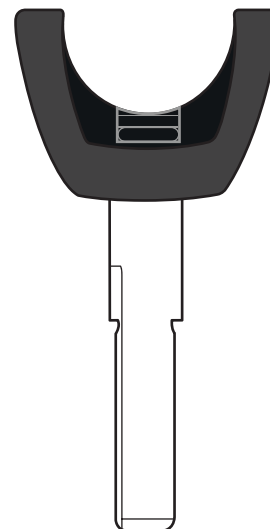
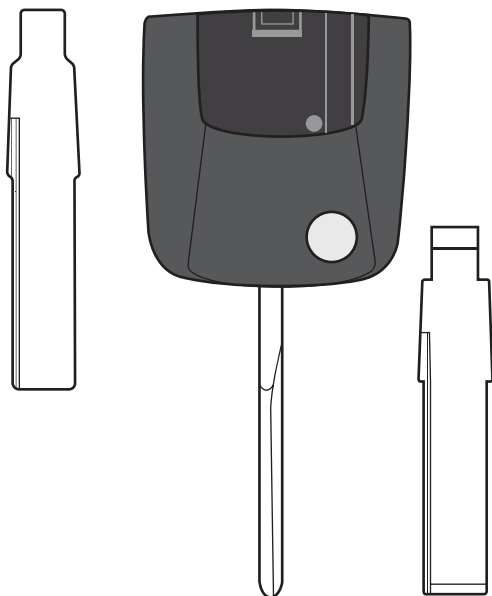

BLADE ONLY FRONT VIEW

BLADE ONLY VIEW

**HU75T**  
VGB1  
SILCA: HU75T  
JMA: HU-HAAC2

**VGB14**  
TP634  
SILCA: HU66

**HU66CT**  
RB1014  
SILCA: NE73AI  
JMA: HU-HAA.TL

**VGB4C**  
TP638  
SILCA: HU66



**SMART**

**SUBARU**

**TOYOTA**

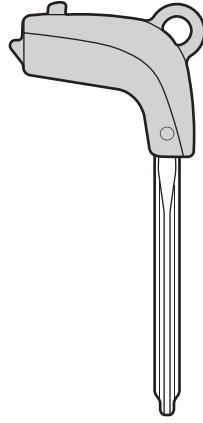
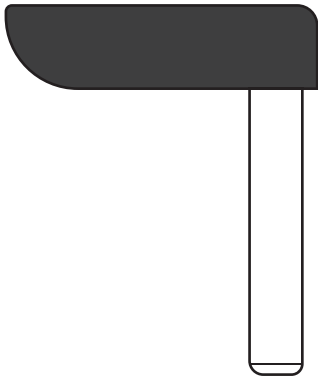

BLADE ONLY  
FRONT VIEW

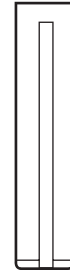
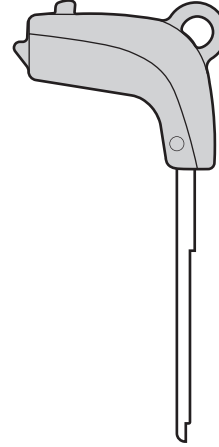

BLADE ONLY  
FRONT VIEW



**REB6**  
TP631

SILCA: VA2  
JMA: RMRN04-BLADE



**VA11T**  
TP619

SILCA: VA11T  
JMA: DAT-15C2



**LXB1**  
TP613

SILCA: TOY48



**LXB2**  
TP614

SILCA: TOY48 (New type)

**BLADES & HORSESHOES**

- KEY MACHINES ■
- KEY BOARDS ■
- KEY CUTTING ACCESSORIES ■
- COINING ■
- NOVELTY ■
- HOUSEHOLD ■
- WINDOW ■
- MORTICE ■
- CAR & TRUCK** ■
- MOTORCYCLE ■
- OTHER VEHICLE ■
- INDUSTRIAL ■

**VAUXHALL**

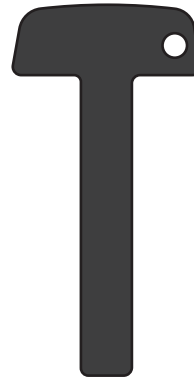
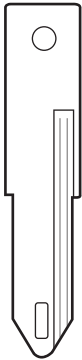

**NE73AI**  
XC132

SILCA: NE73-AI  
JMA: NE-60C1



**REB8**  
TP633

SILCA: VA2/VA6



**HU100T**  
XC257

SILCA: OP-WHC1  
JMA: OP-11C1



**OP-WHC1**  
RB1019

JMA: OP-WHC1



**VXB11**  
RB1036



**HU136TA**  
RB1041

SILCA: HU136TA  
JMA: DAC-4DC1

- NON TRANSPONDERS ■
- PETROL CAP ■
- PODS & INSERTS ■
- BLADES & HORSESHOES ■
- REMOTE KEY SHELLS ■
- CHIPS ■
- KEYLINE HORSESHOES ■
- KEY DIY ■
- XHORSE & WDI ■

VAUXHALL

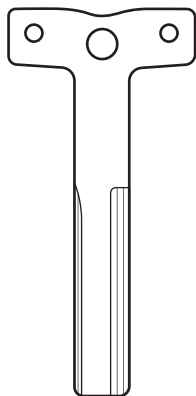

- KEY MACHINES
- KEY BOARDS
- KEY CUTTING ACCESSORIES
- COINING
- NOVELTY
- HOUSEHOLD
- WINDOW
- MORTICE
- CAR & TRUCK
- MOTORCYCLE
- OTHER VEHICLE
- INDUSTRIAL
- NON TRANSPONDERS
- PETROL CAP
- PODS & INSERTS
- BLADES & HORSESHOES
- REMOTE KEY SHELLS
- CHIPS
- KEYLINE HORSESHOES
- KEY DIY
- XHORSE & VVDI



**HU43T**  
RB1047

SILCA: HU43T



**HU189T**  
RB1058

SILCA: HU189T  
JMA: OP-11C3



**NE73CI**  
XC233

SILCA: VA-3I  
JMA: NE-60C3



**HU43TA**  
VXB10

SILCA: HU43TA  
JMA: OP-WHC1



**DAC-5C1**  
RB1042

JMA: DAC-5C1

VAUXHALL

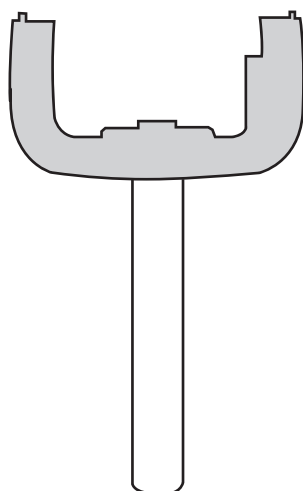

DIAGNOSTIC ENTRY ONLY

Z 4001 - 6000  
Z 1 - 2000

**HU100AT12**  
T108

SILCA: HU100AT12  
JMA: OP-11.TL

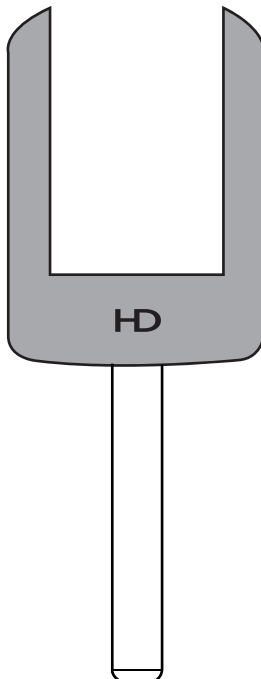

DIAGNOSTIC ENTRY ONLY

**HU100BT12**  
RB1075

JMA: OP-11-TL2

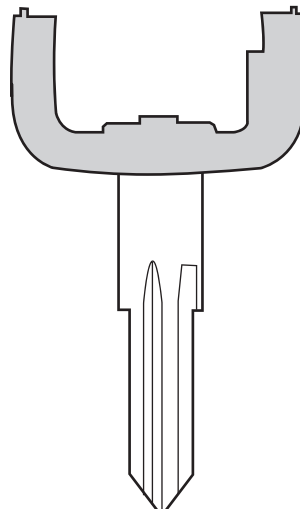

DIAGNOSTIC ENTRY ONLY

S.... 0001 - 5200

**VX1CKBHS**  
RB1076

SILCA: HU46AT  
JMA: OP-S.TL

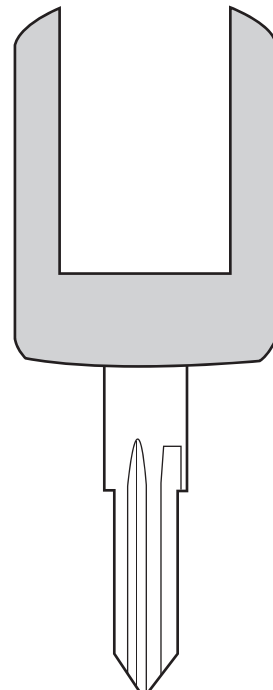

DIAGNOSTIC ENTRY ONLY  
S.... 0001 - 5200

**VX1CKBCT12**  
T77

SILCA: HU46BT  
JMA: OP-S.TL2

## VAUXHALL

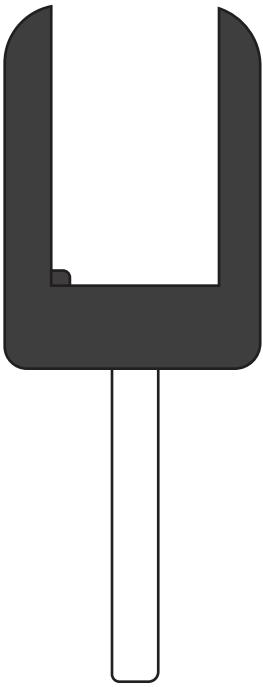

**HU100BT**  
RB1012

SILCA: HU100BT  
JMA: OP-11.TL2

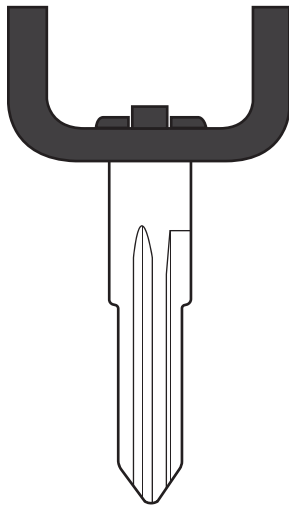

**HU46AT**  
RB1013

SILCA: HU46AT  
JMA: OP-S.TL

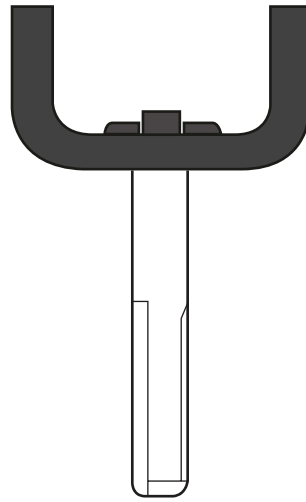

**HU43AT**  
RB1018

SILCA: HU43AT  
JMA: OP-WH.TL

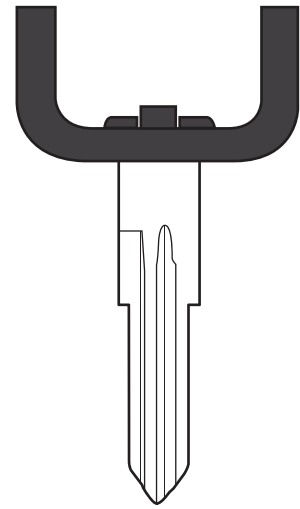

**YM28AT0**  
VXB2

SILCA: YM28AT0  
JMA: OP-D.TL

## BLADES & HORSESHOES

- KEY MACHINES ■
- KEY BOARDS ■
- KEY CUTTING ACCESSORIES ■
- COINING ■
- NOVELTY ■
- HOUSEHOLD ■
- WINDOW ■
- MORTICE ■
- CAR & TRUCK** ■
- MOTORCYCLE ■
- OTHER VEHICLE ■
- INDUSTRIAL ■

## VOLKSWAGEN

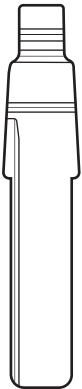

**HU66T**  
RB1015

SILCA: HU66T

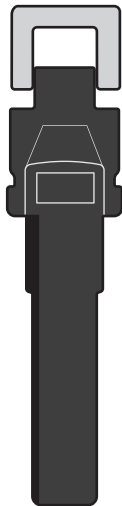

**VGB22**  
TP636

SILCA: HU66



**HU162T**  
RB1031

SILCA: HU162T  
JMA: HU-4C1

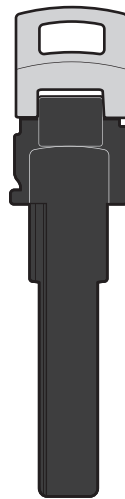

**HU-HAAC10**  
RB1050

JMA: HU-HAAC10



**HU-HAAC11**  
RB1051

JMA: HU-HAAC11

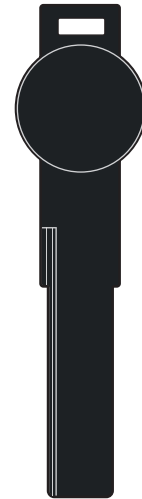

**HU-HAAC13**  
RB1052

JMA: HU-HAAC13

- NON TRANSPONDERS ■
- PETROL CAP ■
- PODS & INSERTS ■
- BLADES & HORSESHOES ■
- REMOTE KEY SHELLS ■
- CHIPS ■
- KEYLINE HORSESHOES ■
- KEY DIY ■
- XHORSE & WDI ■

VOLKSWAGEN

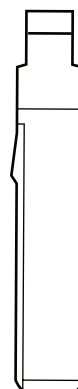
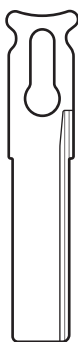
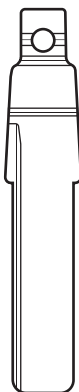

- KEY MACHINES
- KEY BOARDS
- KEY CUTTING ACCESSORIES
- COINING
- NOVELTY
- HOUSEHOLD
- WINDOW
- MORTICE
- CAR & TRUCK
- MOTORCYCLE
- OTHER VEHICLE
- INDUSTRIAL
- NON TRANSPONDERS
- PETROL CAP
- PODS & INSERTS
- BLADES & HORSESHOES
- REMOTE KEY SHELLS
- CHIPS
- KEYLINE HORSESHOES
- KEY DIY
- XHORSE & VDI

**HU-HAAC3**  
RB1054

JMA: HU-HAAC3

**VGB6**  
RB1055

SILCA: HU103T  
JMA: HU-HAAC4

**HU-HAAC5**  
RB1056

JMA: HU-HAAC5

**HU75T**  
VGB1

SILCA: HU75T  
JMA: HU-HAAC2

**VGB23**  
TP830

SILCA: HU64/HU116

**HU75T**  
XC234

SILCA: HU75T  
JMA: HU-HAAC2  
or HU-HAAC1

VOLKSWAGEN

VOLVO

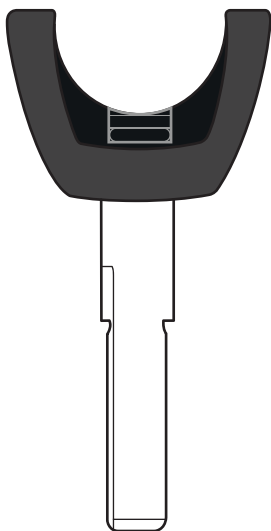

**HU66CT**  
RB1014

SILCA: HU66CT  
JMA: HU-HAA.TL

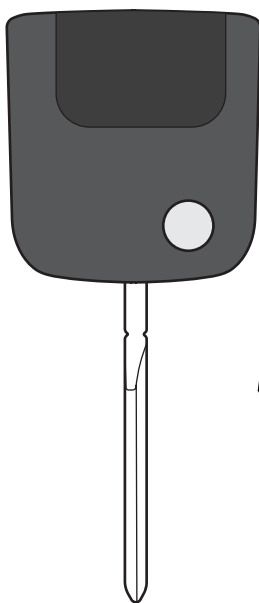

**HU66**  
VGB13

SILCA: HU66  
JMA: RMVW14-FLIP



BLADE ONLY  
FRONT VIEW

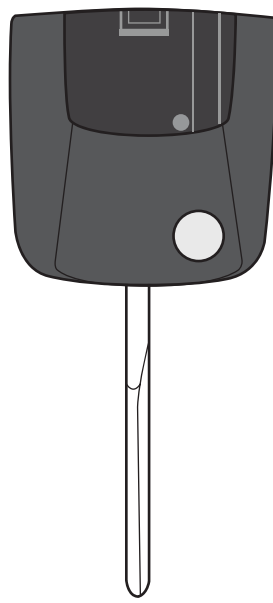

**VGB14**  
TP634

SILCA: HU66



BLADE ONLY  
FRONT VIEW

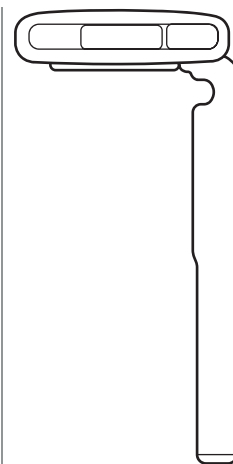

**VOB2**  
RB1035